

# rolly® DIGGER

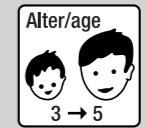

**rolly toys Kundendienst Deutschland:**  
Tel: +49 (0) 95 68 / 856-142  
Fax: +49 (0) 95 68 / 856-183  
e-mail: service@rollytoys.de



2011/05

100.000.800.00

- A** M8 x 70  
1x
  - B** M6 x 70  
1x
  - C** M6 x 55  
1x
  - D** M6 x 35  
1x
  - E** M6 x 20  
1x
  - F** M6 x 16  
1x
  - G** ø 5 x 40  
3x
  - H** M8  
1x
  - I** M6  
5x
  - K** ø 20 x ø 6,4 x 1,25  
1x
- 0 10 20 30 40 50 60 70  
(metrisch • metric) mm

---NORTH & SOUTH AMERICA only---

**180 days warranty**

From the date of purchase + guaranteed spare part service  
The warranty does not cover damages caused by improper use or neglect

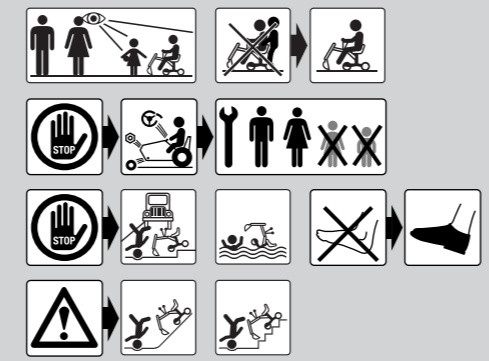

## WARNING

- CHOKING HAZARD: Small parts. Danger of being swallowed. Contains small parts in non assembled state. Must be assembled by adults.
- Adult supervision required.
- Never use near steps, slopes, driveways, hills, roadways, alleys or swimming pool areas.
- Always wear shoes.
- Never allow more than one rider.
- The use of protective gear and a safety helmet is highly recommended.
- Conforms to the requirements of ASTM Standard Consumer Safety Specification on Toy Safety, F 963
- Not suitable for children under 3 years.

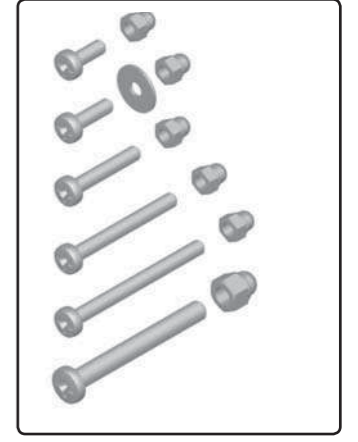
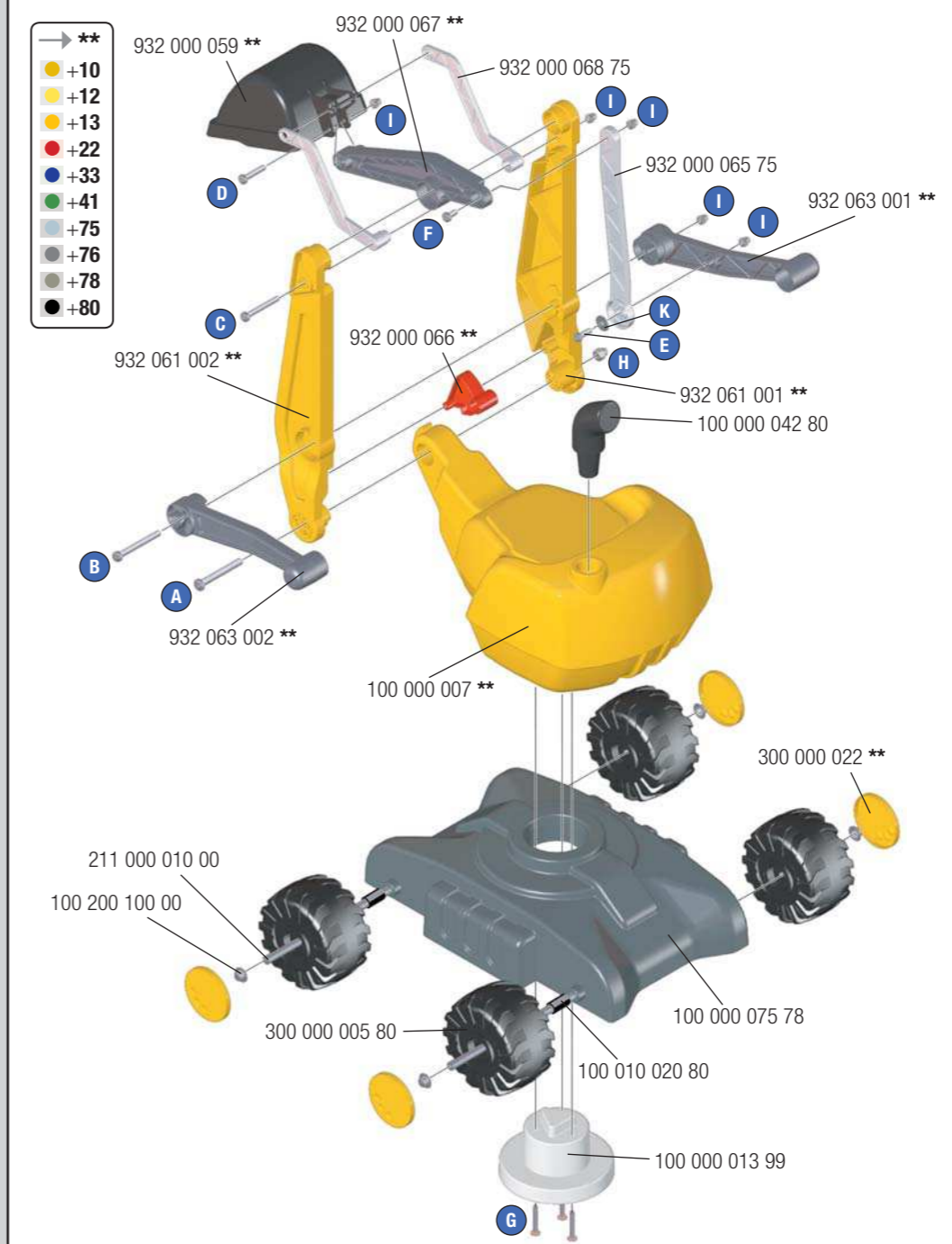

made in Germany

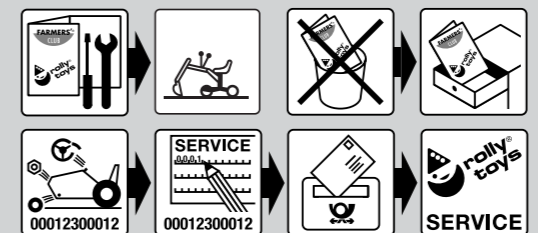

**Franz Schneider GmbH & Co KG**  
P.O.Box 1460  
D-96459 - Neustadt bei Coburg · Germany  
Tel.: +49 (0) 95 68 / 856-0  
Fax.: +49 (0) 95 68 / 856-190  
www.rollytoys.com

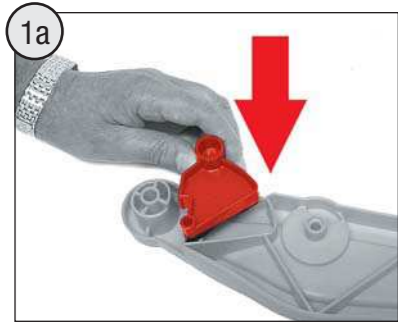

**A**  
2x M8 x 70

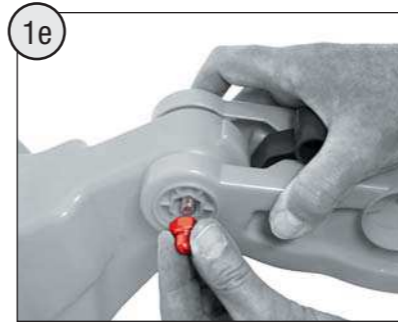

**H**  
2x M8

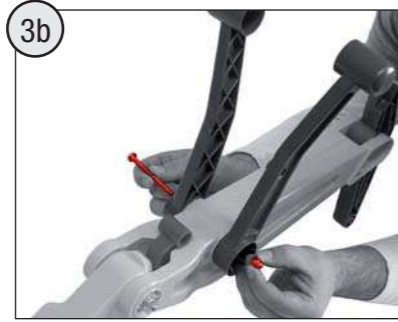
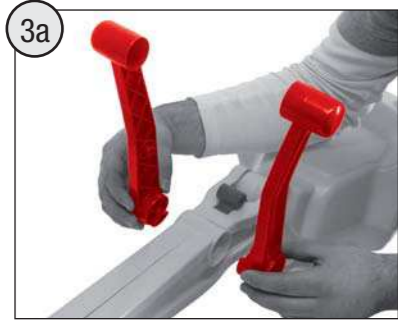
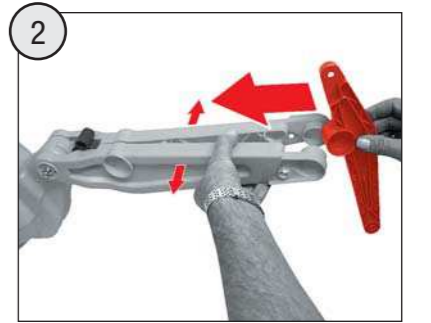
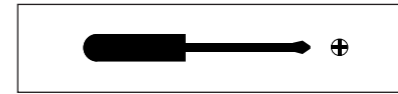
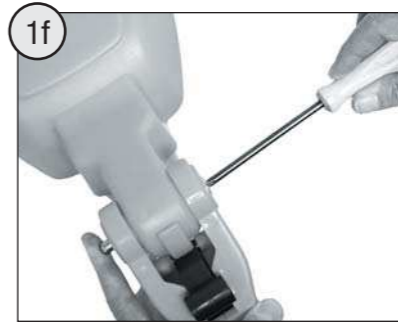

**B**  
1x M6 x 70 **I**  
M6

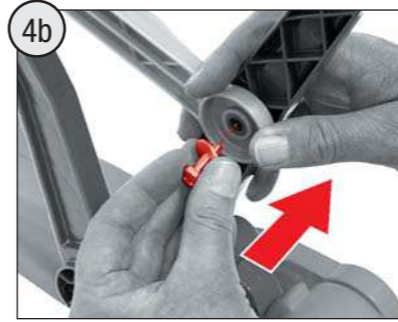
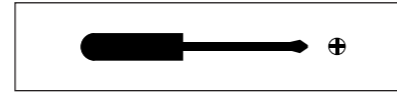
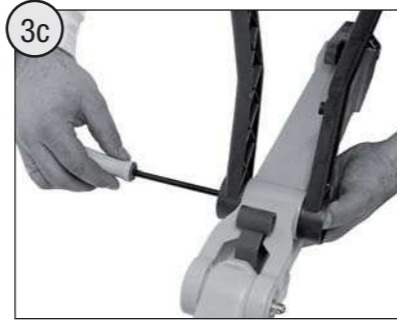

**E**  
1x M6 x 20 **K**  
ø 20

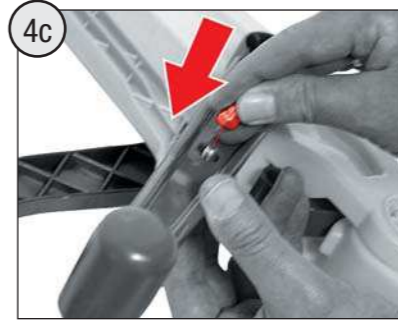

**I**  
1x M6

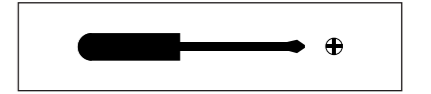
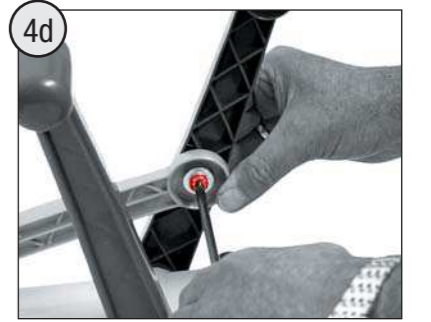

**F**  
1x M6 x 16 **I**  
M6

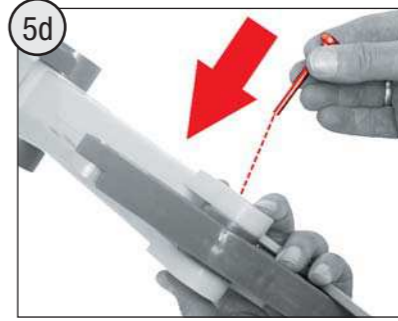
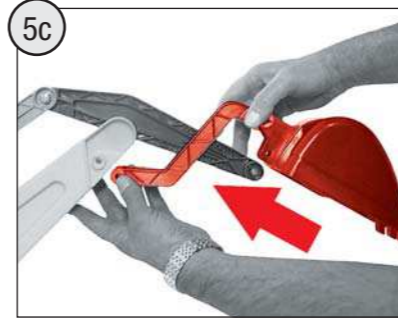
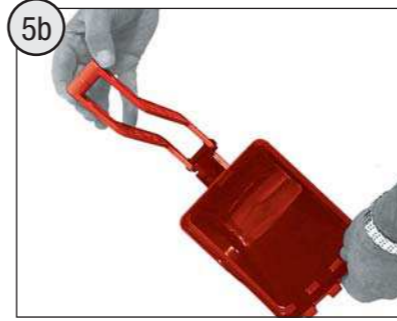
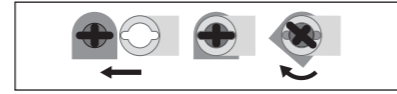
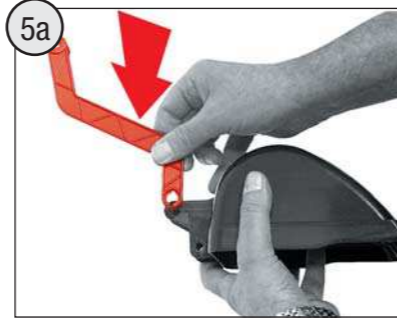
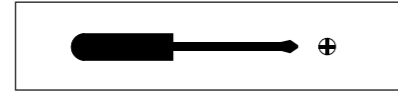
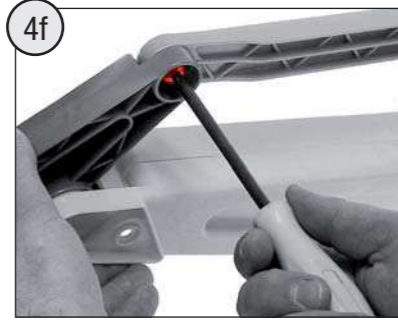

**C**  
1x M6 x 55

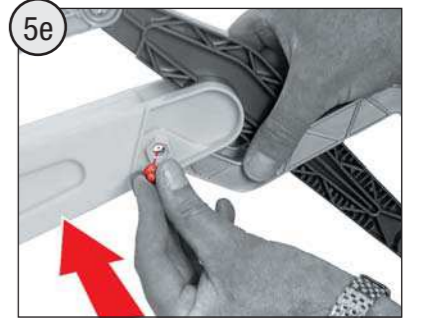

**I**  
1x M6

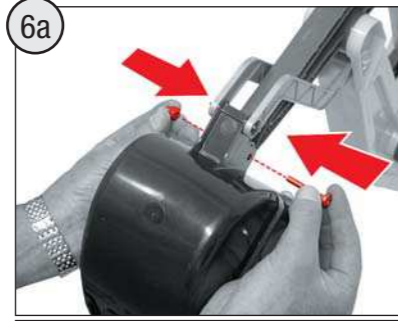
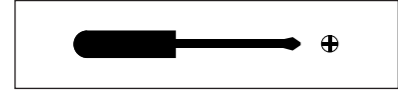
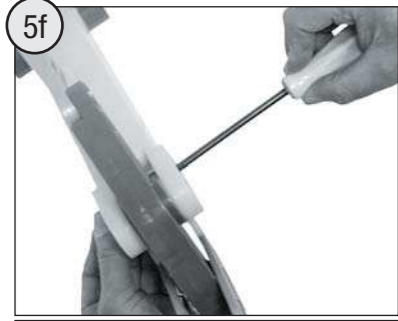

**D**  
1x M6 x 35 **I**  
M6

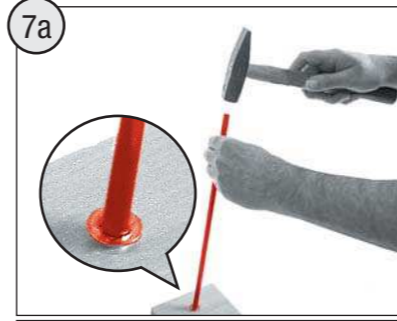

**2x** ø 10 x 450

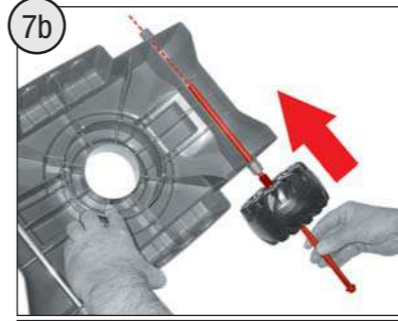

**2x** ø 15 x 20

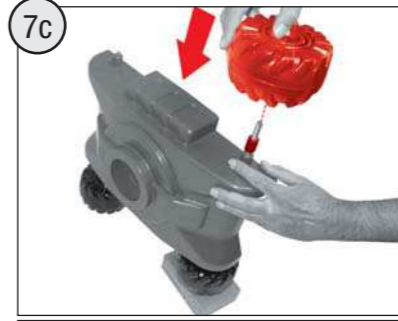

**2x** ø 15 x 20

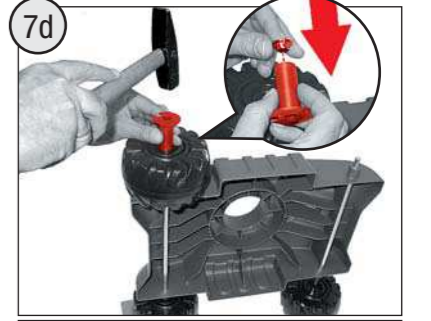

**2x**



**4x**

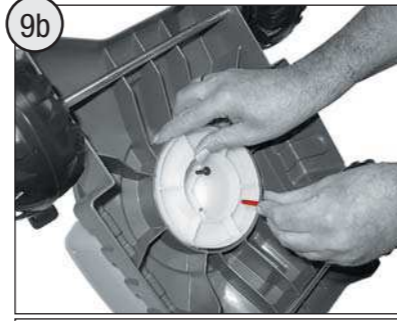

**G**  
**3x** ø 5 x 40

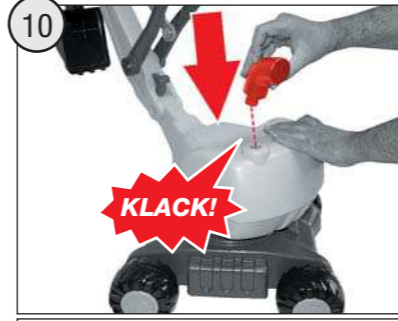
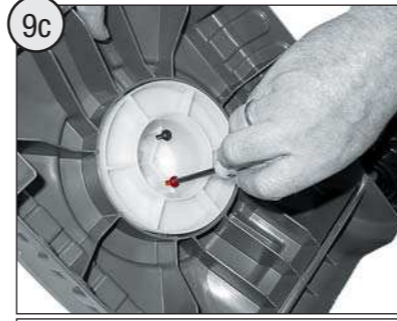

**1x**